

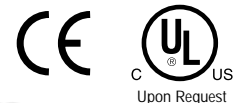





Standard Features







- **Protection Level:** IP66 (NEMA 4X)
- **Technical:** Smooth or Knockout Sidewalls
Gray or Tinted Transparent Cover ^①
Multiple Enclosure Mounting Options
- **Enclosure Material:** Polystyrene or Polycarbonate
- **Gasket Material:** Polyurethane
- **Color:** Light Gray
- **Temperature Range:** Polystyrene
-40°C to 70°C (-40°F to 158°F)
Polycarbonate
-35°C to 120°C (-31°F to 248°F)
- **Accessories:** See section below



Smooth Sidewalls

Ordering Information	Height mm (in)	Polystyrene				Polycarbonate			
		Cat. No.	Type	Cover Color	Std. Pk.	Cat. No.	Type	Cover Color	Std. Pk.
 Enclosure - low cover	90 mm (3.54 in)	110-406	PS 1811-9-o	gray	2	120-406	PC 1811-9-o	gray	2
 Enclosure - high cover	111 mm (4.37 in)	110-906	PS 1811-11-o	gray	2	120-906	PC 1811-11-o	gray	2
 Enclosure - top hat cover	165 mm (6.50 in)	109-406	PS 1811-16-o	gray	2	121-406	PC 1811-16-o	gray	2
 Enclosure - low cover	90 mm (3.54 in)	111-006	PS 1811-9-to	trans.	2	130-006	PC 1811-9-to	trans.	2
 Enclosure - high cover	111 mm (4.37 in)	111-506	PS 1811-11-to	trans.	2	130-506	PC 1811-11-to	trans.	2
 Enclosure - top hat cover	165 mm (6.50 in)	112-006	PS 1811-16-to	trans.	2	131-006	PC 1811-16-to	trans.	2

Sidewalls with PG Knockouts (metric available)

Ordering Information	Height mm (in)	Polystyrene				Polycarbonate			
		Cat. No.	Type	Cover Color	Std. Pk.	Cat. No.	Type	Cover Color	Std. Pk.
 Enclosure - low cover	90 mm (3.54 in)	115-406	PS 1811-9	gray	2	125-406	PC 1811-9	gray	2
 Enclosure - high cover	111 mm (4.37 in)	115-906	PS 1811-11	gray	2	125-906	PC 1811-11	gray	2
 Enclosure - top hat cover	165 mm (6.50 in)	114-406	PS 1811-16	gray	2	126-406	PC 1811-16	gray	2
 Enclosure - low cover	90 mm (3.54 in)	116-006	PS 1811-9-t	trans.	2	135-006	PC 1811-9-t	trans.	2
 Enclosure - high cover	111 mm (4.37 in)	116-506	PS 1811-11-t	trans.	2	135-506	PC 1811-11-t	trans.	2
 Enclosure - top hat cover	165 mm (6.50 in)	117-006	PS 1811-16-t	trans.	2	136-006	PC 1811-16-t	trans.	2

RK Enclosures with Terminal Blocks

Ordering Information	Height	Cat. No.	Type	Cover Color	Std. Pk.
Enclosure - 21 pole/10 AWG Terminal	90 mm (3.54 in)	615-404	RK1811	gray	2
Enclosure - DIN Rail only (TS35)	90 mm (3.54 in)	615-912	RK1811	gray	2

Accessories

Ordering Information	Cat. No.	Type	Std. Pk.
Mounting Plate	195-006	MP1811	1
DIN Rail TS35-144mm	Z-655	TS 35/144	1
Hinge Kit Set	190-005	HK2	1
Mounting Tab Kit	194-001	MT1	1

Please refer to pages 106-113 for additional accessories and detailed information.

^① Clear transparent lids available upon request

Dimensions

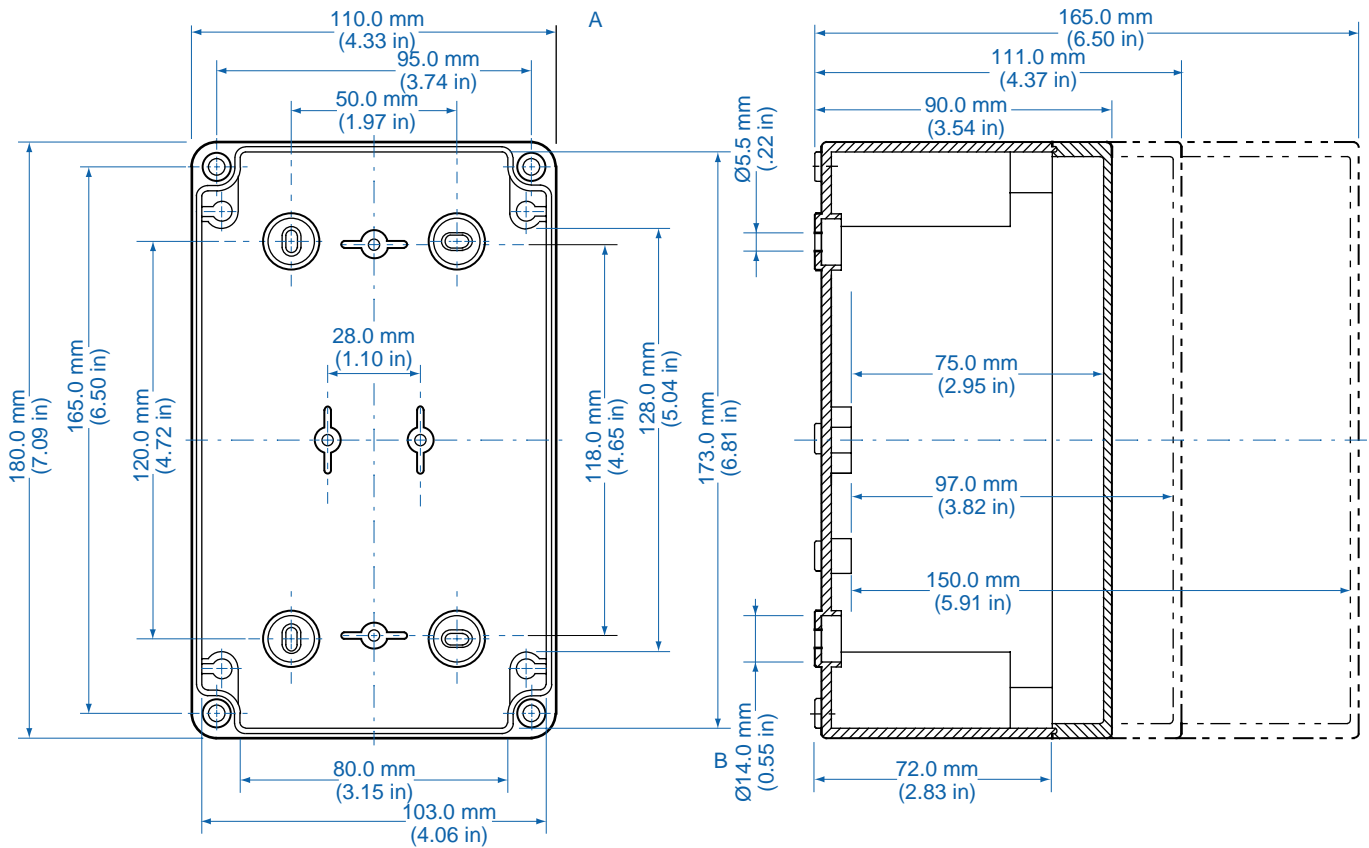

Knockout Positions[®]

Side A

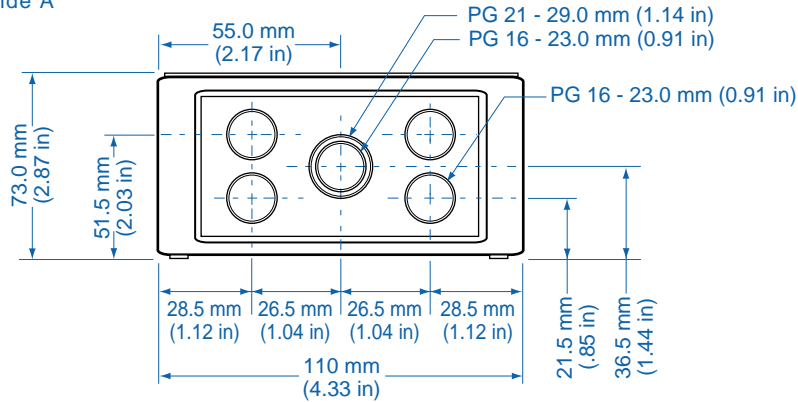

Side B

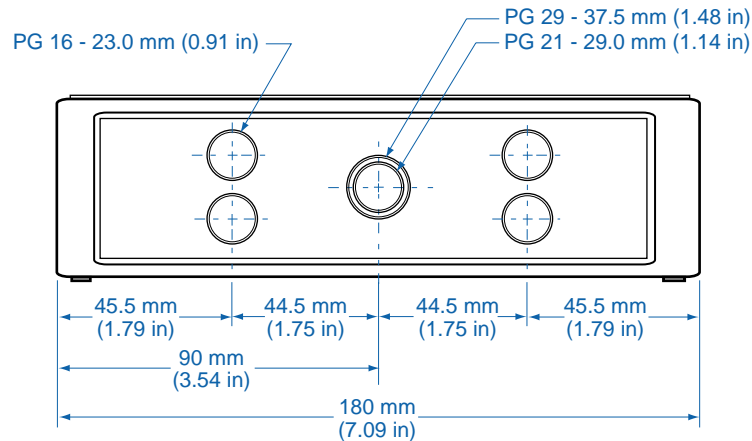

[®] Metric knockouts available upon request