

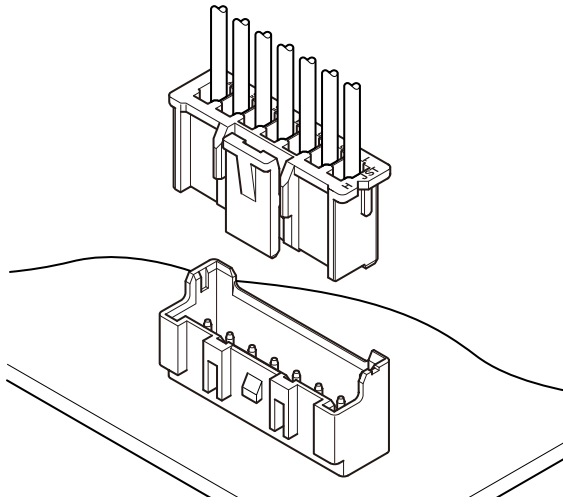

XA CONNECTOR

2.5mm pitch/Disconnectable Crimp style connectors



- Secure locking device
- Solder crack preventive material
- Low insertion force
- Insertion guide mechanism
- Applicable to automatic board mounting machine
- Polarizing boss

Specifications

- Current rating: 3A AC DC (AWG #22, #20)
- Voltage rating: 250V AC DC
- Temperature range: -25°C to +85°C
(including temperature rise in applying electrical current)
- Contact resistance: Initial value/10m Ω max.
After environmental testing/20m Ω max.
- Insulation resistance: 1,000M Ω min.
- Withstanding voltage: 1,000V AC/minute
- Applicable wire: AWG #28 to #20
- Applicable PC board thickness: 1.6mm
- * Compliant with RoHS.
- * Refer to "General Instruction and Notice when using Terminals and Connectors" at the end of this catalog.
- * Contact JST for details.

Standards

- Ⓜ Recognized E60389
- Ⓢ Certified LR20812
- Ⓜ R9851220

PC board layout (viewed from component side) and Assembly layout

<Through-hole type>

Top entry type

without a boss

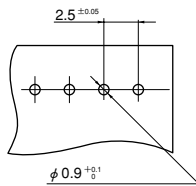

with a boss

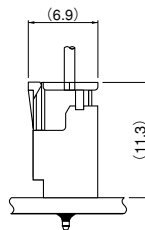
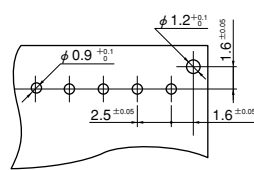

Side entry type

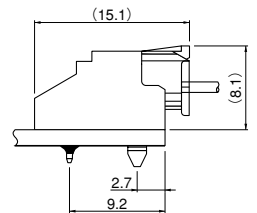
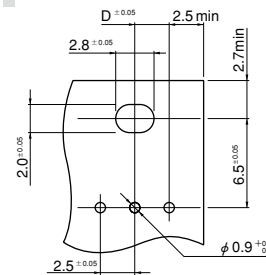

Dimension D: Refer to the Model No. chart of header side entry type.

<SMT type>

Top entry type

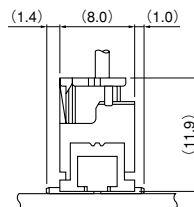
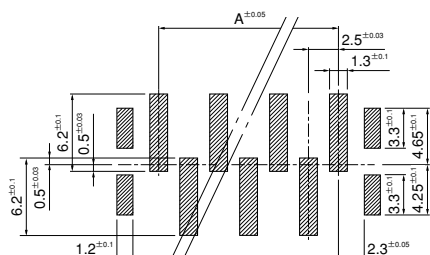

Note: 1. Tolerances are non-cumulative: ±0.05mm for all centers.

2. Hole dimensions differ according to the kind of PC board and piercing method. The dimensions above should serve as a guideline. Contact JST for details.

XA CONNECTOR

Contact

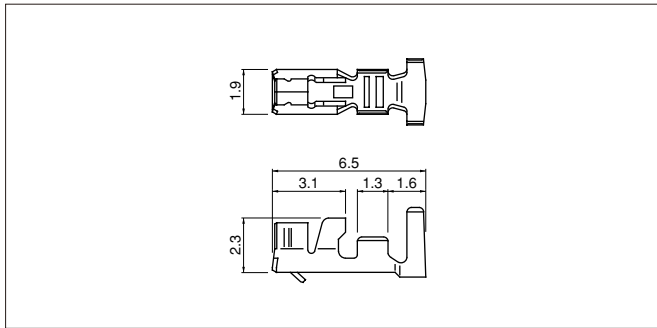

Model No.	Applicable wire			Q'ty / reel
	mm ²	AWG#	Insulation O.D. (mm)	
SXA-001T-P0.6	0.08~0.33	28~22	0.8~1.9	8,000
SXA-01T-P0.6	0.22~0.5	24~20	1.5~1.9	8,000
SXA-001T-P0.6L	0.13~0.33	26~22	1.3~1.7	8,000

Material and Finish

Phosphor bronze, tin-plated (reflow treatment)

RoHS compliance

Note : 1. SXA-001T-P0.6L is low-insertion force type contact, for easier insertion/withdrawal, which would be less resistant to the vibration. The crimp height is different from the standard contact.
2. Contact JST for gold-plated products.

Contact	Crimping machine	Applicator		
		Crimp applicator	Dies	Crimp applicator with dies
SXA-001T-P0.6	AP-K2N	MKS-L	MK/SXA/M-001-06	APLMK SXA/M001-06
		*MKS-SC	SC/SXA/M-001-06	APLSC SXA/M001-06
SXA-001T-P0.6L		MKS-L	MK/SXA-001-06L	APLMK SXA001-06L
		*MKS-SC	SC/SXA-001-06L	APLSC SXA001-06L

Contact	Crimping machine	Applicator		
		Crimp applicator	Dies	Crimp applicator with dies
SXA-01T-P0.6	AP-K2N	MKS-L	MK/SXA/M-01-06	APLMK SXA/M01-06
		*MKS-SC	SC/SXA/M-01-06	APLSC SXA/M01-06

Note: *Strip-crimp applicator

Housing

Standard type

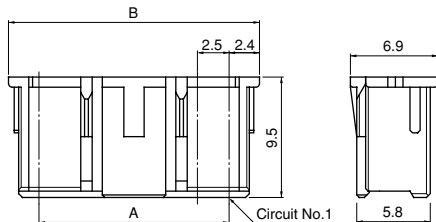

Retainer mountable type

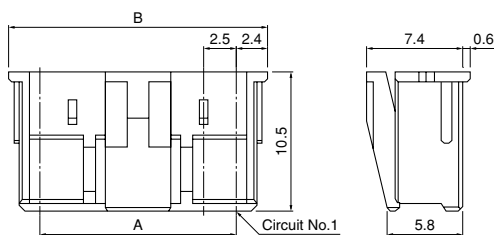

Circuits	Model No.		Dimensions (mm)		Q'ty / bag	
	Standard type	Retainer mountable type	A	B	Standard type	Retainer mountable type
2	XAP-02V-1	XARP-02V	2.5	7.3	1,000	1,000
3	XAP-03V-1	XARP-03V	5.0	9.8	1,000	1,000
4	XAP-04V-1	XARP-04V	7.5	12.3	1,000	1,000
5	XAP-05V-1	XARP-05V	10.0	14.8	1,000	1,000
6	XAP-06V-1	XARP-06V	12.5	17.3	1,000	1,000
7	XAP-07V-1	XARP-07V	15.0	19.8	1,000	1,000
8	XAP-08V-1	XARP-08V	17.5	22.3	1,000	1,000
9	XAP-09V-1	XARP-09V	20.0	24.8	1,000	1,000
10	XAP-10V-1	XARP-10V	22.5	27.3	1,000	1,000
11	XAP-11V-1	XARP-11V	25.0	29.8	1,000	1,000
12	XAP-12V-1	XARP-12V	27.5	32.3	1,000	1,000
13	XAP-13V-1	XARP-13V	30.0	34.8	1,000	1,000
14	XAP-14V-1	XARP-14V	32.5	37.3	500	1,000
15	XAP-15V-1	XARP-15V	35.0	39.8	500	1,000
18	—	XARP-18V	42.5	47.3	—	500
20	XAP-20V-1	—	47.5	52.3	500	—

Material

PA 66, UL94V-0, natural (white)

RoHS compliance

<For reference> As the color identification, the following alphabet shall be put in the underlined part. For availability, delivery and minimum order quantity, contact JST.

<Standard type>

ex. **XAP-02V-1-oo**

(blank)...natural (white)

K...black R...red E...blue Y...yellow L...lemon yellow

M...green O...orange N...brown H...gray P...purple

LE...light blue PK...pink FY...vivid yellow Z...ivory

<Retainer mountable type>

ex. **XARP-02V-oo**

(blank)...natural (white)

K...black R...red E...blue L...lemon yellow

XA CONNECTOR

Retainer

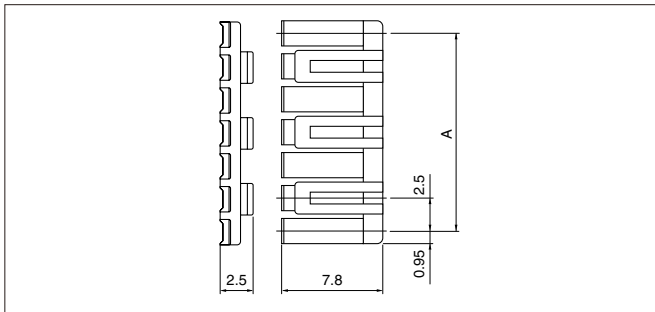

Material

Glass-filled PA 66, UL94V-0, natural (ivory)

RoHS compliance

Circuits	Model No.	A	Q'ty / bag
2	XMS-02V	2.5	1,000
3	XMS-03V	5.0	1,000
4	XMS-04V	7.5	1,000
5	XMS-05V	10.0	1,000
6	XMS-06V	12.5	1,000
7	XMS-07V	15.0	1,000
8	XMS-08V	17.5	1,000
9	XMS-09V	20.0	1,000
10	XMS-10V	22.5	1,000
11	XMS-11V	25.0	1,000
12	XMS-12V	27.5	1,000
13	XMS-13V	30.0	1,000
14	XMS-14V	32.5	1,000
15	XMS-15V	35.0	1,000

Through-hole type shrouded header

Top entry type without a boss

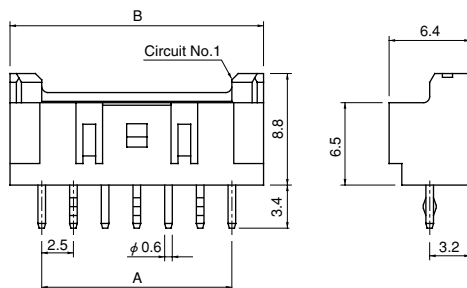

Top entry type with a boss

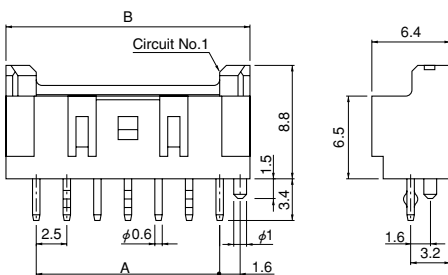

Side entry type with a hook

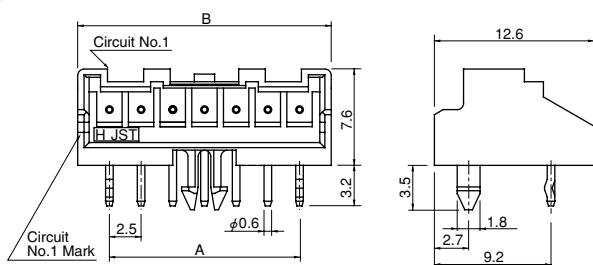

Circuits	Model No.		Dimensions (mm)		Q'ty / box
	Top entry type		A	B	
	Without a boss	With a boss			
2	B02B-XASK-1	B02B-XASK-1-A	2.5	7.5	1,000
3	B03B-XASK-1	B03B-XASK-1-A	5.0	10.0	400
4	B04B-XASK-1	B04B-XASK-1-A	7.5	12.5	400
5	B05B-XASK-1	B05B-XASK-1-A	10.0	15.0	400
6	B06B-XASK-1	B06B-XASK-1-A	12.5	17.5	400
7	B07B-XASK-1	B07B-XASK-1-A	15.0	20.0	250
8	B08B-XASK-1	B08B-XASK-1-A	17.5	22.5	250
9	B09B-XASK-1	B09B-XASK-1-A	20.0	25.0	250
10	B10B-XASK-1	B10B-XASK-1-A	22.5	27.5	250
11	B11B-XASK-1	B11B-XASK-1-A	25.0	30.0	200
12	B12B-XASK-1	B12B-XASK-1-A	27.5	32.5	200
13	B13B-XASK-1	B13B-XASK-1-A	30.0	35.0	100
14	B14B-XASK-1	B14B-XASK-1-A	32.5	37.5	100
15	B15B-XASK-1	B15B-XASK-1-A	35.0	40.0	100
20	B20B-XASK-1	B20B-XASK-1-A	47.5	52.5	100

Material and Finish

Pin: Copper alloy, copper-undercoated, tin-plated (reflow treatment)
Wafer: Glass-filled PA 66, UL94V-0, natural (ivory)

RoHS compliance This product displays (LF)(SN) on a label.

Note: Contact JST for gold-plated products.

Circuits	Model No.	Dimensions (mm)			Q'ty / box
	Side entry type with a hook	A	B	D	
2	S02B-XASS-1	2.5	7.5	1.25	250
3	S03B-XASK-1	5.0	10.0	2.50	250
4	S04B-XASK-1	7.5	12.5	3.75	200
5	S05B-XASK-1	10.0	15.0	5.00	200
6	S06B-XASK-1	12.5	17.5	6.25	200
7	S07B-XASK-1	15.0	20.0	7.50	200
8	S08B-XASK-1	17.5	22.5	8.75	100
9	S09B-XASK-1	20.0	25.0	10.00	100
10	S10B-XASK-1	22.5	27.5	11.25	100
11	S11B-XASK-1	25.0	30.0	12.50	100
12	S12B-XASK-1	27.5	32.5	13.75	100
13	S13B-XASK-1	30.0	35.0	15.00	100
14	S14B-XASK-1	32.5	37.5	16.25	100

Material and Finish

Pin: Copper alloy, copper-undercoated, tin-plated (reflow treatment)
Wafer: Glass-filled PA 66, UL94V-0, natural (ivory)

RoHS compliance This product displays (LF)(SN) on a label.

Note: 1. Dimension D...See PC board layout.

2. Contact JST for gold-plated products.

<For reference> As the color identification, the following alphabet shall be put in the underlined part.
For availability, delivery and minimum order quantity, contact JST.

ex. S02B-XASK-1

S...natural (ivory)

K...black R...red E...blue M...green Y...yellow

XA CONNECTOR

Through-hole type shrouded header

N type

Top entry type without a boss

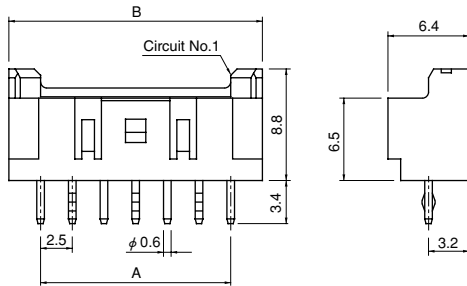

Top entry type with a boss

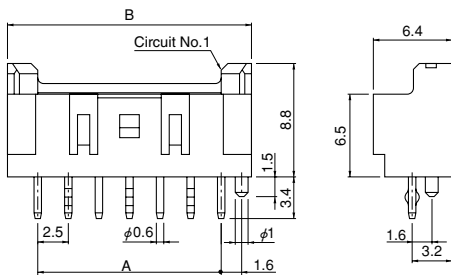

Side entry type without a hook

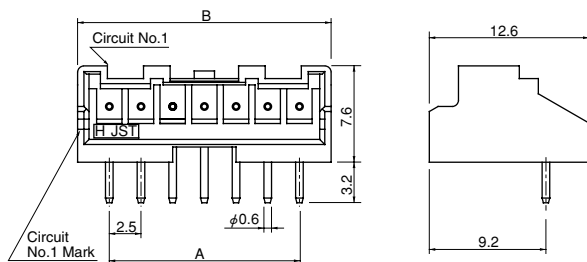

Circuits	Model No.		Dimensions (mm)		Q'ty / box
	Top entry type		A	B	
	Without a boss	With a boss			
2	B02B-XASK-1N	B02B-XASK-1N-A	2.5	7.5	1,000
3	B03B-XASK-1N	B03B-XASK-1N-A	5.0	10.0	400
4	B04B-XASK-1N	B04B-XASK-1N-A	7.5	12.5	400
5	B05B-XASK-1N	B05B-XASK-1N-A	10.0	15.0	400
6	B06B-XASK-1N	B06B-XASK-1N-A	12.5	17.5	400
7	B07B-XASK-1N	B07B-XASK-1N-A	15.0	20.0	250
8	B08B-XASK-1N	B08B-XASK-1N-A	17.5	22.5	250
9	B09B-XASK-1N	B09B-XASK-1N-A	20.0	25.0	250
10	B10B-XASK-1N	B10B-XASK-1N-A	22.5	27.5	250
11	B11B-XASK-1N	B11B-XASK-1N-A	25.0	30.0	200
12	B12B-XASK-1N	B12B-XASK-1N-A	27.5	32.5	200
13	B13B-XASK-1N	B13B-XASK-1N-A	30.0	35.0	100
14	B14B-XASK-1N	B14B-XASK-1N-A	32.5	37.5	100
15	B15B-XASK-1N	B15B-XASK-1N-A	35.0	40.0	100
18	B18B-XASK-1N	—	42.5	47.5	100

Material and Finish

Pin: Copper alloy, copper-undercoated, tin-plated (reflow treatment)
Wafer: Glass-filled PA 66, UL94V-0, natural (white)

RoHS compliance This product displays (LF)(SN) on a label.
Note: Not TÜV approved.

<For reference> As the color identification, the following alphabet shall be put in the underlined part.
For availability, delivery and minimum order quantity, contact JST.

ex. **B02B-XASK-1N-A**

S...natural (white)

K...black R...red E...blue Y...yellow L...lemon yellow

M...green O...orange N...brown H...gray P...purple

LE...light blue PK...pink FY...vivid yellow

Circuits	Model No.		Dimensions (mm)		Q'ty / box
	Side entry type without a hook		A	B	
2	S02B-XASS-1N-BN	S02B-XASS-1N-BN	2.5	7.5	250
3	S03B-XASS-1N-BN	S03B-XASS-1N-BN	5.0	10.0	250
4	S04B-XASS-1N-BN	S04B-XASS-1N-BN	7.5	12.5	200
5	S05B-XASS-1N-BN	S05B-XASS-1N-BN	10.0	15.0	200
6	S06B-XASS-1N-BN	S06B-XASS-1N-BN	12.5	17.5	200
7	S07B-XASS-1N-BN	S07B-XASS-1N-BN	15.0	20.0	200
8	S08B-XASS-1N-BN	S08B-XASS-1N-BN	17.5	22.5	100
9	S09B-XASS-1N-BN	S09B-XASS-1N-BN	20.0	25.0	100
10	S10B-XASS-1N-BN	S10B-XASS-1N-BN	22.5	27.5	100
11	S11B-XASS-1N-BN	S11B-XASS-1N-BN	25.0	30.0	100
12	S12B-XASS-1N-BN	S12B-XASS-1N-BN	27.5	32.5	100
13	S13B-XASS-1N-BN	S13B-XASS-1N-BN	30.0	35.0	100
14	S14B-XASS-1N-BN	S14B-XASS-1N-BN	32.5	37.5	100

Material and Finish

Pin: Copper alloy, copper-undercoated, tin-plated (reflow treatment)
Wafer: Glass-filled PA 66, UL94V-0, natural (white)

RoHS compliance This product displays (LF)(SN) on a label.

Note: 1. As for side entry type, we recommend to use a product with a boss (hook) because stress is applied directly to fillet part when handling the wire. When using the side entry type product without a boss (hook), please handle the wire with care.
2. Not TÜV approved.

XA CONNECTOR

SMT type shrouded header

(2 circuits)

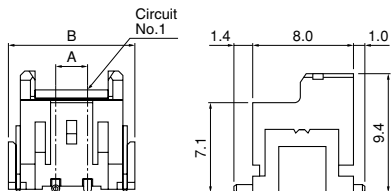

(3 to 15 circuits)

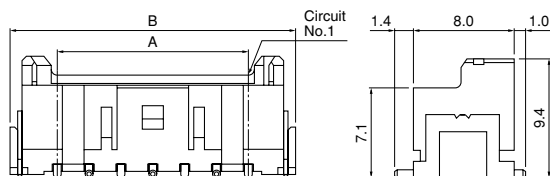

Circuits	Model No.	Dimensions (mm)		Q'ty / reel
		A	B	
2	BM02B-XASS-TF	2.5	10.0	500
3	BM03B-XASS-TF	5.0	12.5	500
4	BM04B-XASS-TF	7.5	15.0	500
5	BM05B-XASS-TF	10.0	17.5	500
6	BM06B-XASS-TF	12.5	20.0	500
7	BM07B-XASS-TF	15.0	22.5	500
8	BM08B-XASS-TF	17.5	25.0	500
9	BM09B-XASS-TF	20.0	27.5	500
12	BM12B-XASS-TF	27.5	35.0	500
13	BM13B-XASS-TF	30.0	37.5	500
15	BM15B-XASS-TF	35.0	42.5	500

Material and Finish

Pin: Copper alloy, copper-undercoated, tin-plated (reflow treatment)
 Wafer: PA, UL94V-0, natural
 Solder tab: Brass, copper-undercoated, tin-plated (reflow treatment)

RoHS compliance This product displays (LF)(SN) on a label.

<For reference> As the color identification, the following alphabet shall be put in the underlined part. For availability, delivery and minimum order quantity, contact JST.

ex. **BM02B-XASS-TF**
 S...natural
 K...black R...red E...blue M...green D...orange
 L...lemon yellow

Through-hole type shrouded header on radial-tape

Top entry type without a boss

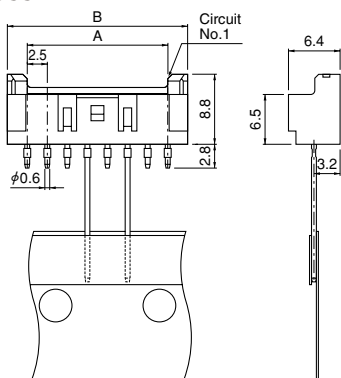

Top entry type with a boss

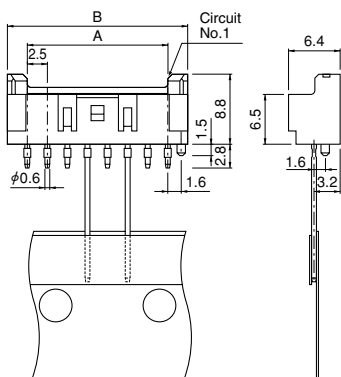

Circuits	Model No.		Dimensions (mm)		Q'ty / box
	Top entry type without a boss	Top entry type with a boss	A	B	
2	B02B-XASS-1-T	—	2.5	7.5	1,000
3	B03B-XASS-1-T	B03B-XASS-1-A-T	5.0	10.0	1,000
4	B04B-XASS-1-T	B04B-XASS-1-A-T	7.5	12.5	500
5	B05B-XASS-1-T	B05B-XASS-1-A-T	10.0	15.0	500
6	B06B-XASS-1-T	B06B-XASS-1-A-T	12.5	17.5	500
7	B07B-XASS-1-T	B07B-XASS-1-A-T	15.0	20.0	500
8	B08B-XASS-1-T	B08B-XASS-1-A-T	17.5	22.5	500

Material and Finish

Pin: Copper alloy, copper-undercoated, tin-plated (reflow treatment)
 Wafer: Glass-filled PA 66, UL94V-0, natural (ivory)

RoHS compliance This product displays (LF)(SN) on a label.

<For reference> As the color identification, the following alphabet shall be put in the underlined part. For availability, delivery and minimum order quantity, contact JST.

ex. **B03B-XASS-1-A-T**
 S...natural (ivory)
 R...red E...blue M...green

Taping specifications

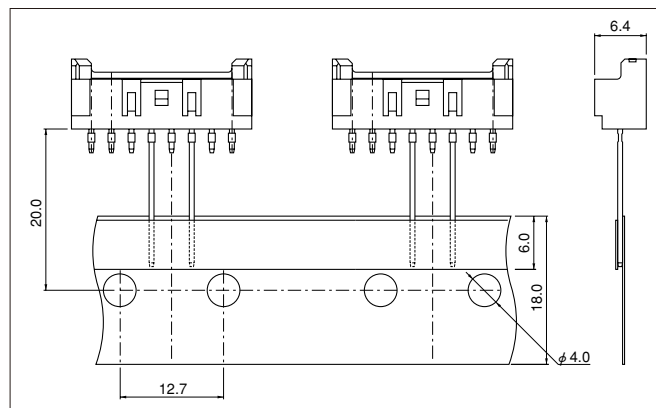

Note: Conforms to JIC C 0806 of "Tape packaging of components with unidirectional leads on continuous tapes".

XA CONNECTOR

Packaging specifications

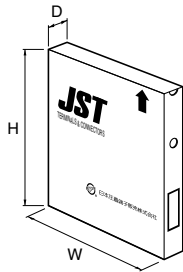

Distance between the end of the tape and the first connector's center line (either end)

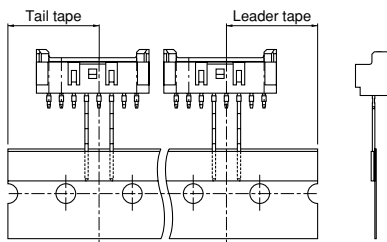

Package type	Flat pack (zigzag folded)	
Distance between folds	24 indexing holes per fold (304.8mm)	
Box size	316(W)×45(D)×330(H)mm	
Distance between the end of the tape and the first connector's center line (either end)	19.05mm	
Quantity	2, 3 circuits	1,000 pcs. / box
	4~8 circuits	500 pcs. / box

*Note: Products of different packaging specifications are also available.
Contact JST for details.*